

# RCA

**user manual**  
manual de usuario

EZDVD1  
EZDVD2

**IMPORTADOR**  
Comercializadora Thomson de México, S.A. de C.V.  
Álvaro Obregón No. 151. Piso 13.  
Col. Roma. Delegación Cuauhtémoc  
C.P. 06700. México, D.F.  
Telefono: 52-55-11-020360  
RFC: CTM-980723-K55

**EXPORTER**  
Thomson Inc.  
P.O. Box 1976  
Indianapolis, IN 46206-1976  
© 2007 Thomson Inc.  
Trademark(s) ® Registered  
Marca(s) ® Registrada(s)  
Marque(s) ® Déposée(s)  
[www.mysmallwonder.com](http://www.mysmallwonder.com)  
Printed In China / Impreso en China

5645 6000 (EN/E)

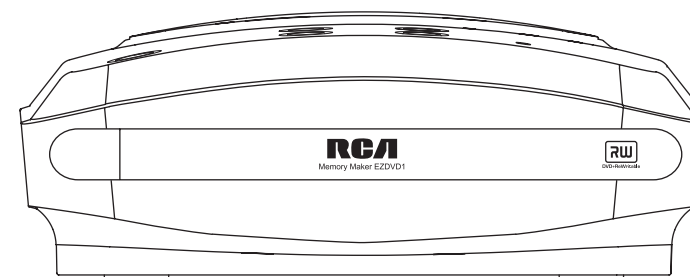

It is important to read this instruction book prior to using your new product for the first time.  
Es importante leer este manual antes de usar por vez primera su equipo.

## Safety information

EN

### FCC Information

This device complies with Part 15 of the FCC Rules. Operation is subject to the following two conditions: (1) This device may not cause harmful interference, and (2) this device must accept any interference received, including interference that may cause undesired operation.

In accordance with FCC requirements, changes or modifications not expressly approved by Thomson Inc. could void the user's authority to operate this product. This device generates and uses radio frequency (RF) energy, and if not installed and used properly, this equipment may cause interference to radio and television reception. If this equipment does cause interference to radio or television reception (which you can determine by unplugging the unit), try to correct the interference by one or more of the following measures:

- Re-orient the receiving antenna (that is, the antenna for the radio or television that is "receiving" the interference).
- Move the unit away from the equipment that is receiving interference.
- Plug the unit into a different wall outlet so that the unit and the equipment receiving interference are on different branch circuits.

If these measures do not eliminate the interference, please consult your dealer or an experienced radio/television technician for additional suggestions. Also, the Federal Communications Commission has prepared a helpful booklet, "How To Identify and Resolve Radio TV Interference Problems." This booklet is available from the U.S. Government Printing Office, Washington, DC 20402. Please specify stock number 004-000-00345-4 when ordering copies. This product complies with DHHS Rules 21 CFR Subchapter J. Applicable at the date of manufacture.

### For your safety

The AC power plug is polarized (one blade is wider than the other) and only fits into AC power outlets one way. If the plug won't go into the outlet completely, turn the plug over and try to insert it the other way. If it still won't fit, contact a qualified electrician to change the outlet, or use a different one. Do not attempt to bypass this safety feature.

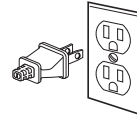

Main plug is used as the disconnect device, it shall remain operable and should not be obstructed during intended use. To be completely disconnected the apparatus from supply mains, the main plug of the apparatus shall be disconnected from the mains socket outlet completely.

**CAUTION: TO PREVENT ELECTRIC SHOCK, MATCH WIDE BLADE OF PLUG TO WIDE SLOT, FULLY INSERT.**

### For your records

In the event that service should be required, you may need both the model number and the serial number. In the space below, record the date and place of purchase, and the serial number:

Model No.  
Remote Control No.  
Date of Purchase  
Place of Purchase  
Serial No.

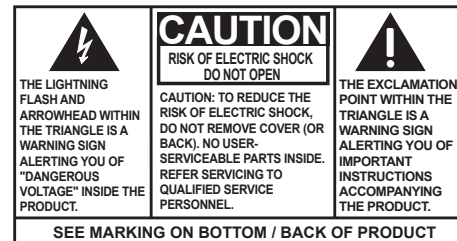

**WARNING: TO PREVENT FIRE OR ELECTRICAL SHOCK HAZARD, DO NOT EXPOSE THIS PRODUCT TO RAIN OR MOISTURE.**

**Rating label is located on the bottom of apparatus.**

## IMPORTANT SAFETY INFORMATION

### Please read and save for future reference

Some of the following information may not apply to your particular product; however, as with any electronic product, precautions should be observed during handling and use.

- Read these instructions.
- Keep these instructions.
- Heed all warnings.
- Follow all instructions.
- Do not use this apparatus near water.
- Clean only with dry cloth.
- Do not block any ventilation openings. Install in accordance with the manufacturer's instructions.
- Do not install near any heat sources such as radiators, heat registers, stoves, or other apparatus (including amplifiers) that produce heat.
- Do not defeat the safety purpose of the polarized or grounding-type plug. A polarized plug has two blades with one wider than the other. A grounding type plug has two blades and a third grounding prong. The wide blade or the third prong is provided for your safety. If the provided plug does not fit into your outlet, consult an electrician for replacement of the obsolete outlet.
- Protect the power cord from being walked on or pinched particularly at plugs, convenience receptacles, and the point where they exit from the apparatus.
- Only use attachments/accessories specified by the manufacturer.
- Use only with the cart, stand, tripod, bracket, or table specified by the manufacturer, or sold with the apparatus. When a cart is used, use caution when moving the cart/apparatus combination to avoid injury from tip-over.
- Unplug this apparatus during lightning storms or when unused for long periods of time.



- Refer all servicing to qualified service personnel. Servicing is required when the apparatus has been damaged in any way, such as power-supply cord or plug is damaged, liquid has been spilled or objects have fallen into the apparatus, the apparatus has been exposed to rain or moisture, does not operate normally, or has been dropped.

### Additional safety information

- Apparatus shall not be exposed to dripping or splashing and no objects filled with liquids, such as vases, shall be placed on the apparatus.
- Always leave sufficient space around the product for ventilation. Do not place product in or on a bed, rug, in a bookcase or cabinet that may prevent air flow through vent openings.
- Do not place lighted candles, cigarettes, cigars, etc. on the product.
- Connect power cord only to AC power source as marked on the product.
- Care should be taken so that objects do not fall into the product.
- Do not attempt to disassemble the cabinet. This product does not contain customer serviceable components.

If your product operates on batteries, adhere to the following precautions:

- Any battery may leak electrolyte if mixed with a different battery type, if inserted incorrectly, or if all batteries are not replaced at the same time.
- Any battery may leak electrolyte or explode if disposed of in fire or an attempt is made to charge a battery not intended to be recharged.
- Discard leaky batteries immediately. Leaking batteries can cause skin burns or other personal injury. When discarding batteries, be sure to dispose of them in the proper manner, according to your state/provincial and local regulations.

## Contents

EN

<b>Safety information</b>	<b>DVD playback</b>
FCC information .....2	Basic playback.....13
For your safety	Info banner
For your record	Advanced playback
IMPORTANT SAFETY INFORMATION .....3	Repeat playback
<b>Getting started</b>	<b>Playback of recorded discs</b>
Box contents .....5	Title menu.....14
Things to consider before you connect	Chapter menu.....15
Discs you can use for recording	Playing a chapter
Discs you can play	Record on a deleted title
Don't infringe	Unfinalizing a disc
<b>Connections</b>	<b>Playback of other discs</b>
Connecting a TV .....6	File browser .....16
Connecting Small Wonder camcorder	Editing playlist
Other connection options .....7	Repeat and shuffle playback
<b>General controls</b>	<b>Player menus</b>
Main unit .....8	Live signal .....17
Remote control	Play disc
<b>Discs for playback and recording</b>	Disc operation (Format Disc, Finalize, Rename Disc Label)
Discs for recording .....9	Recording manager (Quality, Auto Chapter)
Discs for playback	Setup (Language, Parental Lock, AV Setting, Reset, Version)
<b>Display</b>	<b>More information</b>
Screen menus and banners.....10	Troubleshooting .....19
<b>Watching images from connected devices</b>	Precautions .....22
Selecting input source .....10	Maintenance
<b>Recording from Small Wonder camcorder</b>	Note
Initial setup .....11	Technical Specifications
Instant recording	<b>Limited Warranty</b>
Selective recording	For US .....23
<b>Recording from other sources</b>	
Initial setup .....13	
Recording	

The descriptions and characteristics given in this document are given as a general indication and not as a guarantee. In order to provide the highest quality product possible, we reserve the right to make any improvement or modification without prior notice. The English version serves as the final reference on all products and operational details should any discrepancies arise in other languages.

## Getting started

### Box contents

EN



Small Wonder Memory Maker

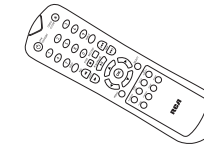

Remote control (with batteries)



Power adapter with cables



1 set of audio video cables (RCA-type)

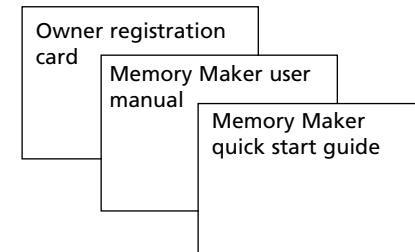

### Things to consider before you connect

#### Protect components from overheating

- Do not block ventilation holes on any of the components. Arrange the components so that air can circulate freely.
- Do not stack components.
- When you place components in a stand, make sure you allow adequate ventilation.
- If you connect an audio receiver or amplifier, place the unit on the top shelf.

#### Position cables properly to avoid audio interference

- Insert each cable firmly into the designated jack.
- If you place components above the TV, route all cables down the side of the back of the TV instead of straight down the middle of the back of the TV.

### Discs you can use for recording

Refer to page 9 for details.

### Discs you can play

Refer to page 9 for details.

### Don't infringe

This product should only be used for the purposes for which it is sold, that is, entertainment, violating no copyright law. Any attempts to use this product for which it is not intended is unlawful and therefore not condoned by Thomson.

## Connections

### Connecting a TV

EN

1. If you intend to use your Small Wonder Memory Maker for watching DVD or recording other external sources (e.g. TV, digital camcorder), you **MUST** connect the unit to the TV with the supplied audio video cables (color-coded red, white and yellow).
  - These are the audio/video cables. The yellow cable carries the video signal, and the red and white cables carry the audio signal.

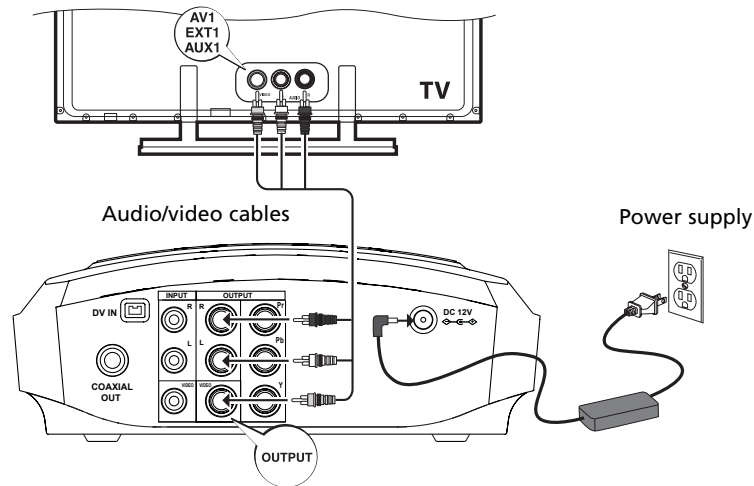

2. Turn on the TV and tune it to the correct Video Input Channel. To do so, you usually press the AV button on the TV remote control until you get to the video input channel that matches how the Small Wonder Memory Maker is connected to the TV. When you are on the right channel, you can see the unit's player menu. Since access to a TV's video input channel varies from one manufacturer to the next, it is difficult to provide specific instructions for your particular brand. Please refer to the user manual of your TV.

### Connecting Small Wonder camcorder

Turn on the unit and place the Small Wonder camcorder to the connector on the top of the unit. To do so, you have to put the camcorder upside down for connection. The Camcorder Docked indicator lights when the camcorder is connected.

Whenever the camcorder is connected to the unit, the unit will automatically switch to view input from the camcorder even if you are watching images from other sources (e.g. INPUT1 or DV).

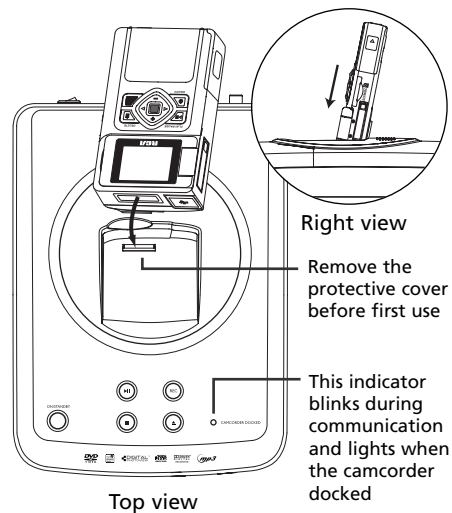

Top view

### Other connection options

There are several ways in which you can incorporate your unit into an Audio-Video system. This depends on the sockets and other appliances you have. Sound and image quality depend to a large extent on the types of connections used.

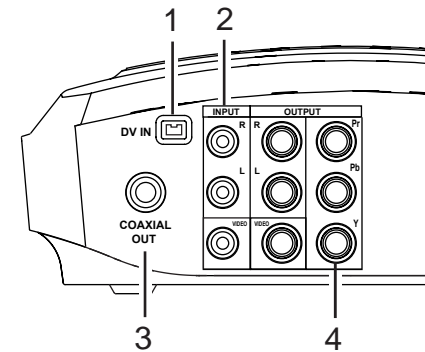

#### Input options

##### 1. DV IN

- For connection with external source (e.g. digital camcorder) with an IEEE1394 cable (not provided).

##### 2. AV input

- These jacks receive audio and video from a compatible component, such as a satellite receiver.
- An additional set of audio/video cables (not provided) is required for this connection.

#### Output options

##### 3. Coaxial out (digital sound)

- The digital sound of a DVD video disc when played is permanently available on the coaxial socket of your unit. Use this socket by connecting it to a decoder or Dolby Digital amplifier.
- A digital coaxial cable (not provided) is required for this connection.

##### 4. Component video outputs (Y, Pb, Pr) (YUV)

- The Y, Pb, Pr sockets deliver an optimum image quality due to the separation of the video signal into three separate components.
- To obtain the best image quality possible, use very high quality cables for connections. Your dealer can provide YUV cables that are sold together and come in the standard colour codes (red, green and blue) used for these types of sockets and cables.
- If you use the Component sockets Y, Pb, Pr (also called YUV), you must configure the output video signal so that these sockets deliver either an interlaced YUV signal (component interlaced) or a progressive PS signal (component progressive) by pressing **VIDEO OUT** on the remote control.
- Do not forget to also connect the audio cables, because **Component cables only transmit images, and not sound**.

EN

# General controls

EN

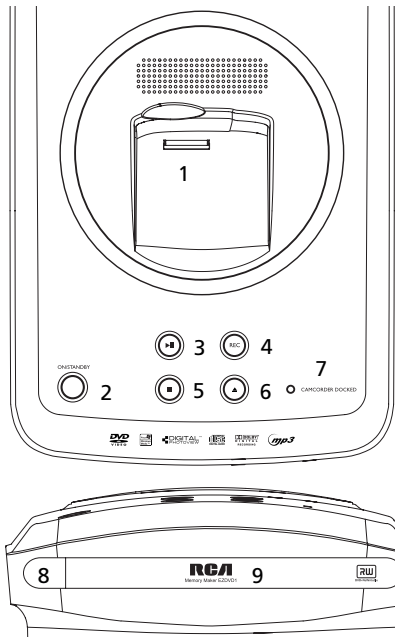

## Main unit

1. Connector for Small Wonder camcorder
2. **ON/STANDBY** – To turn on or off the unit. The indicator around the button lights when the unit is turned off.
3. **■** – To stop playback or recording.
4. **REC** – To start the recording. The indicator around the button lights during recording and flashes while initializing or stopping recording.
5. **■** – To stop playback or recording.
6. **▲** – To open or close the disc tray.
7. **CAMCORDER DOCKED** – This indicator lights when the Small Wonder camcorder is connected to the unit.
8. Remote control sensor
9. Disc tray

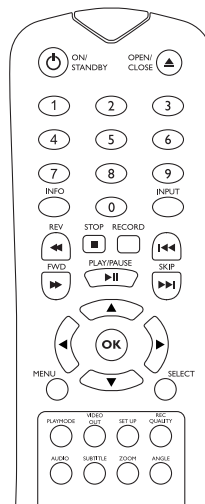

## Remote control

**ON/STANDBY** – To turn on or off the unit.

**OPEN/CLOSE ▲** – To open or close the disc tray.

**0-9** – Numeric keys

**INFO** – To show the on-screen info banners (p. 13).

**INPUT** – To select the audio visual sources (p. 10).

**REV ◀ / FWD ▶** – To play in fast or slow motion (p. 13).

**STOP ■** – To stop playback or recording.

**RECORD** – To start recording (p. 11-13).

**PLAY/PAUSE ▶||** – To start or pause the playback.

**SKIP ◀◀ / ▶▶** – To skip backward or forward a chapter, title or track (p. 11-13).

**▲ ▼ ◀ ▶** – To move through on-screen menus in the direction of the arrow button (e.g., to move right, press ▶).

**OK** – To confirm selections in menus.

**MENU** – To access the disc menu or select PBC mode of VCD on or off (p. 14).

**SELECT** – To select video for recording from the Small Wonder camcorder (p. 12).

**PLAYMODE** – To select repeat or shuffle playback modes (p. 14, 16).

**VIDEO OUT** – To select between progressive or interlace output mode when component video connections are made (p.7); to select displaying images on the connected TV or Small Wonder camcorder while the camcorder is connected to the unit (p. 12).

**SET UP** – To access the Memory Maker's player menus (p. 17).

**REC QUALITY** – To select the recording quality (p. 17).

**AUDIO, SUBTITLE, ANGLE** – To select audio, subtitle and angle setting respectively (p. 13-14).

**ZOOM** – To enlarge image when watching DVD or VCD (p. 13).

- Insert 2 batteries (AAA, LR03) at the back of the remote control prior to use.
- Point the remote control at the unit, not the TV, to operate. Make sure there is a clear path between the remote control and the unit, so the signal is not blocked.
- Refer to the pages in the user manual for operation details as indicated in the parentheses.



EN

# Discs for playback and recording

## Discs for recording

- DVD+R 2.4x, 4x, 8x, 16x and 32x
- DVD-R 2.4x, 4x, 8x, 16x and 32x
- DVD+RW 2.4x, 4x and 8x
- DVD-RW 2.4x, 4x and 8x

- This recorder is not compatible with DVD-RAM, CD-R, or CD-RW discs for recording.
- This recorder is compatible with dual-layered discs.
- The first time you load a disc, the DVD recorder will format it. This should only take a few seconds.
- DVD±R disc must be finalized (refer to recording on page 11) after recording for playing in another DVD player. The DVD recorder automatically asks if you want to finalize a disc when you eject the disc.

## Discs for playback

- DVD Video discs with region code 1 or ALL
- DVD±R/RW discs, DVD±R discs (the discs must be finalized for playback)
- CDs (Audio CDs, CD-R, CD-RW, mp3, jpeg discs)
- Video CD discs (VCD, SVCD)

- Discs for recording (DVD±R/RW) are not assigned region numbers.
- You cannot play the following types of discs: Laserdiscs, CD-I, CD-ROM (computer only discs), discs recorded using other broadcast standards (i.e. PAL or SECAM), or DVD-RAM discs.
- Some discs may not be compatible due to laser pickup and disc design.

## Display

EN

### Screen menus and banners

- **Disc menus** – each DVD video disc offers menus for accessing more disc features. The disc menu is usually displayed on the screen when a DVD disc is loaded. You can also, at any time, display the main menu of the disc by pressing **MENU**. Availability of some functions (e.g. angle, subtitle) depend on the disc's manufacturer.
- **Info banners** – while playing a disc, you can display or hide info banners by pressing **INFO**. The banners contain information of the current disc.
- **Action bars** – they appear at the bottom of the TV screen for accessing more functions while the unit is playing recorded discs, mp3, wma, jpeg, or audio CD discs. Highlight the icons in the action bars using the navigation keys (< >) and confirm selections by pressing **OK**.

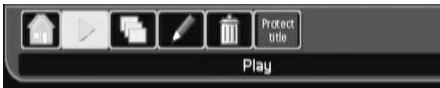
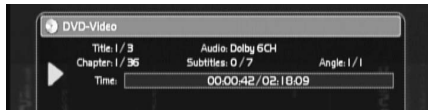

- **Player menus** – the unit has functions that are not accessible using the remote control keys. Press **SETUP** to access the player menus. Move around in the menus using the navigation keys ( ^ v < > ) and confirm your selections by pressing **OK**.

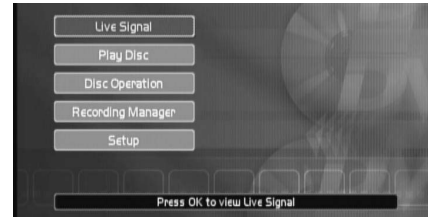

- If a menu item or icon appears in "grey" it means that the function is not available.
- When this symbol (lightbulb with a slash) is displayed, it indicates that the function you are requesting is not available or that the key used is incorrect.
- The screen saver may have been triggered if the unit is left idle, press **OK** to quit the screen saver mode.



## Watching images from connected devices

### Selecting input source

To select viewing a device connected to your unit (e.g. satellite receiver, digital camcorder), press **INPUT** on the remote control to show the action bar at the bottom of the screen. Select the input source (DV, INPUT1 or INPUT2) by pressing < / > and then **OK**.

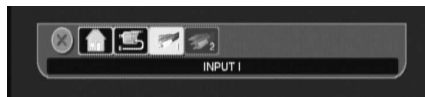

Input	Source
DV	DV input connected with an IEEE1394 cable
INPUT1	AV input connected with a set of Audio/Video cables
INPUT2	Small Wonder camcorder connected on the top of the unit

## Recording from Small Wonder camcorder

### Initial setup

1. Press **ON/STANDBY** to turn on the Memory Maker.
  2. Load a recordable disc in the player. Refer to page 9 for details on recordable discs.
  3. Connect the Small Wonder camcorder to the unit. Refer to page 6 for details.
- If you want to record videos from the SD/MMC card installed in the Small Wonder camcorder, press **the red RECORD button on the camcorder** while the camcorder is connected to the unit and video playback is stopped. This can switch to accessing videos from the internal memory to the SD/MMC card or vice versa.

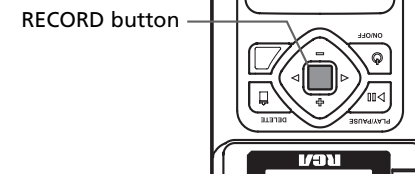

- Once connected, the below message will show on the LCD screen of the camcorder:

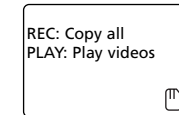

The card icon shows if videos on the SD/MMC card are accessed.

### Option 1: unit is NOT connected to a TV

1. After the camcorder is connected to the unit, press **▶||** to start video playback on the LCD screen. While viewing, you may:
  - Press **SKIP ◀◀ / ▶▶** to skip backward or forward a video.
  - Press **▶||** to pause or resume the playback.
  - Press **REV ◀◀ / FWD ▶▶** to quickly play backward or forward. Press **▶||** to resume normal playback.
2. While viewing the videos, press **SELECT** to mark the videos that you want to record. When the button is pressed, a message "Marked" is displayed on the LCD screen.
- You may de-select the video by pressing **SELECT** while you are viewing the same video. A message "Unmarked" is displayed.
3. After videos are selected, press **■** to stop playback. The below message will show on the LCD screen of the camcorder:

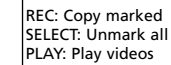

4. Press **REC** or **RECORD** twice to start recording the selected videos on the camcorder.
  - The LCD screen turns off and the indicator around the **REC** button on top of the unit lights during recording.
  - You may also press **SELECT** to de-select all videos you have marked or press **▶||** to view the videos again.
5. Press **■** anytime to stop recording. Otherwise, recording will stop automatically when finished.
6. You will be asked to finalize the disc when you unload the disc. If you want to play the disc on other DVD players, press **▶||**. Otherwise, press **▲** to unload the disc.

### Instant recording

1. Press **REC** or **RECORD** twice to start recording all videos on the camcorder.
  - Alternatively, press **▶||** to start playback of the videos. Repeat the step above to record only the video you are currently viewing.
2. Press **■** to stop recording. Otherwise, recording will stop automatically when finished.
3. You will be asked to finalize the disc when you unload the disc. If you want to play the disc on other DVD players, press **▶||**. Otherwise, press **▲** to unload the disc.

### Selective recording

You may record on a disc only desired videos on the camcorder with or without the help of a TV connected to the unit. Refer to one of the two options below according to your connections.

## Recording from Small Wonder camcorder

EN

### Option 2: unit is connected to a TV

- After the camcorder is connected to the unit, press **VIDEO OUT** to show the video playback on the TV screen. Remember to turn on the TV and tune it to the correct Video Input Channel.
- A video browser shows on the TV screen as below:



- Press **^**/**v** to highlight a video. A preview is available on the right of the screen.
- Press **</>** to select option (d) on the action bar at the bottom of the screen and then press **OK** to select the highlighted video to record. A check mark shows next to the video title. Repeat this step to select more videos to record.

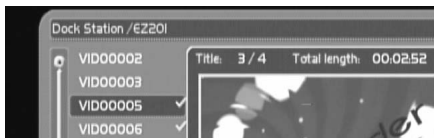

- You may de-select the video by pressing **OK** again while option (d) is highlighted.
  - Press **</>** to select option (c) and then press **OK** to de-select all marked videos at once.
  - Press **SELECT** on the remote control may also select or de-select highlighted videos.
- Press **REC** or **RECORD** twice to start recording. The indicator around the **REC** button on top of the unit lights during recording.
  - Press **■** anytime to stop recording. Otherwise, recording will stop automatically when finished.

- You will be asked to finalize the disc when you unload the disc. If you want to play the disc on other DVD players, press **▶▶**. Otherwise, press **▲** to unload the disc.

Explanation of the other two options (a) and (b) on the action bar:

- (a) Returns to the main page of the player menu.
- (b) Plays the highlighted video in full screen mode. While viewing, you may:
- Press **SKIP** **◀◀**/**▶▶** to skip backward or forward a video.
  - Press **▶||** to pause or resume the playback.
  - Press **REV** **◀◀**/**FWD** **▶▶** to quickly play backward or forward. Press **▶||** to resume normal playback.

## Recording from other sources

### Initial setup

- Press **ON/STANDBY** to turn on the unit.
- Load a recordable disc in the player. Refer to page 9 for details on recordable discs.
- Connect an external device (e.g. satellite receiver, digital camcorder) to the DV IN or AV input jacks on the back of the unit. Refer to page 7 for connection options.

### Recording

- Press **INPUT** on the remote control to show the action bar at the bottom of the screen. Select the input source (DV or INPUT1) by pressing **</>** and then **OK**.
  - Images from the external device should be seen from the connected TV.
  - Do NOT connect the Small Wonder camcorder on the unit.
- Press **REC** or **RECORD** to start recording. The indicator around the **REC** button on top of the unit lights during recording.

### One touch recording

Press **REC** or **RECORD** again to select among 30min, 60min, 90min and 120min. Recording will stop automatically after the selected duration. The unit will keep on recording until the disc is full no one touch recording setting is made.

- Record duration options are available for selection only when the disc has the sufficient disc space.

- Press **■** anytime to stop recording.
- You will be asked to finalize the disc when you unload the disc. If you want to play the disc on other DVD players, press **▶▶**. Otherwise, press **▲** to unload the disc.

No scheduled recording is available with this unit.

## DVD playback

### Basic playback

- Tune the TV to the AV channel connected with the unit.
- Press **ON/STANDBY** to turn on the unit.
- Press **▲** to open the disc tray. Insert a disc in the disc tray. Press **▲** to close the disc tray.
- Press **▶||** to start playback. Some discs may start to play automatically.
- Press **■** to stop playback.
  - The unit remembers the stopped point on a disc. When the disc starts to play again, the unit picks up from the stopped point unless the disc is unloaded or the unit is unplugged, or **■** is pressed twice.
- Press **▲** to open the disc tray.

### Info banner

Press **INFO** to display or hide the info banner for checking the playback time, audio, subtitle and angle settings.

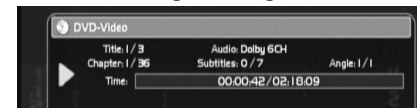

### Advanced playback

- Quick search** – Press **REV** **◀◀**/**FWD** **▶▶** during playback (press one or more times to select speed). Press **▶||** to resume normal playback.
- Forward slow motion** – Press **▶||** and then **FWD** **▶▶** during playback (press one or more times to select speed). Press **▶||** to resume normal playback.
- Skipping** – Press **SKIP** **◀◀**/**▶▶** to skip to the previous or next chapter or track on the disc.
- Zoom** – Press **ZOOM** during playback (press one or more times to select zoom options: 2x, 3x, 4x and 1/2x). Move the enlarged image by pressing **^**/**v**/**<**/**>** to see a specific part of it. Press **ZOOM** several times to return to the original format.
- Audio setting** – press **AUDIO** during playback to change audio setting by pressing **^**/**v** and then **OK**. Available setting options depend on the disc's manufacturer.

## DVD playback

EN

- **Subtitle setting** – press **SUBTITLE** during playback to change subtitle setting by pressing  $\wedge/\vee$  and then **OK**. Available setting options depend on the disc's manufacturer.
- **Angle setting** – press **ANGLE** during playback to change angle setting by pressing  $\wedge/\vee$  and then **OK**. Available setting options depend on the disc's manufacturer.
- **DVD menu** – press **MENU** to access the DVD disc menu or to select the PBC menu (if available) of VCD on or off.

### Repeat playback

Press **PLAYMODE** during playback to select among the repeat modes: chapter repeat, title repeat, all repeat, and repeat off. The selected repeat mode shows briefly on the TV screen.

## Playback of recorded discs

### Title menu

When a recorded non-finalized DVD±R or a DVD±RW disc is loaded and played. The following title menu shows on TV:



Press  $\wedge/\vee$  to highlight a title and  $\langle / \rangle$  to highlight an icon on the action bar at the bottom of the screen and press **OK** to select.

- Returns to the main page of the player menu.
- Starts playback of the highlighted title.

- Switches to chapter menu of the highlighted title.
- Normally, video discs are divided into titles and titles are subdivided into chapters.
- Renames the highlighted title.
- Deletes the highlighted title.
- Protects/unprotects the highlighted title from deletion or modification.

### Chapter menu



When the chapter menu of a title is shown (refer to (c) in the title menu):

- Press  $\wedge/\vee$  to highlight a chapter and  $\langle / \rangle$  to highlight an icon on the action bar at the bottom of the screen and press **OK** to select.
- Goes back to the title menu.
  - Starts playback of the highlighted chapter.
  - Hides or unhides the highlighted chapter (it is not possible to hide the first chapter of a title). Hidden chapters will not be played.
  - Combines highlighted chapters.
  - Combines all chapters in a title.

### Playing a chapter

When a chapter is played (refer to (b) in the chapter menu):

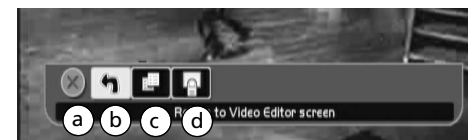

Press **OK** to show the action bar, press  $\langle / \rangle$  to highlight an icon on the action bar at the bottom of the screen and press **OK** to select.

- Hides the action bar.
- Returns to the chapter menu.
- Adds chapter mark.
- Selects the current image as thumbnail of the title.

### Record on a deleted title

The free disc space available after deleting a title on a DVD±RW disc can be recorded again. For details on deleting a title, refer to Title menu on page 14.

EN



- From the title menu, press  $\wedge/\vee$  to highlight a deleted title and  $\langle / \rangle$  to highlight the record icon (red dot) on the action bar at the bottom of the screen.
  - Press **OK** to mark the free disc space for recording. New DVD recording will start from the marked space instead of the end of the disc.
- New recording on the free disc space must not exceed the original size or length of the deleted title.

### Unfinalizing a disc

For a finalized DVD±RW disc, press **REC** or **RECORD** to unfinalize the disc for further recording or editing. Alternatively, go to the *Disc Operation* menu in the player menus to unfinalize the disc. Refer to page 17 for details.

## Playback of other discs

### File browser

EN

A file browser shows on the TV screen when a disc with any of the following file types is loaded.

- Audio CD
- mp3 or wma (audio)
- jpeg (picture)
- mpeg2 and mpeg1 (video)



Press  $\wedge/\vee$  to highlight a folder or file. Press  $\leftarrow/\rightarrow$  to highlight an icon on the action bar at the bottom of the screen and press **OK** to select.

- Returns to the main page of the player menu.
- Starts playback of the highlighted file (or open the highlighted folder).
- Adds the highlighted file in the playlist.
- Views and edits the playlist. Refer to Editing playlist.
- Filters the files on the disc according to audio, video, picture or all types.
- Selects the playback mode including combinations of repeat and shuffle playback. Shuffle playback is only available for audio CDs, jpeg or mp3/wma discs. Playback will be in random order when shuffle playback is activated.
- Shows files in thumbnail view (only applicable to picture files).
- Starts picture slideshow with music. To start playing audio files in the playlist or current folder (if playlist contains no audio files) with pictures in the playlist.

### Editing playlist

Press  $\wedge/\vee$  to highlight a file in the playlist. Press  $\leftarrow/\rightarrow$  to highlight an icon on the action bar at the bottom of the menu and press **OK** to select.



- Hides the playlist.
- Starts playback of the highlighted file.
- Moves the highlighted file.
- Deletes the highlighted file.
- Mixes the order of the files in the playlist.
- Clears all files in the playlist.

When viewing jpeg files:

- Press **ANGLE** to rotate the images.
- Press **ZOOM** during playback (press one or more times to select zoom options: 2x, 3x, 4x and 1/2x). Move the enlarged image by pressing  $\wedge/\vee/\leftarrow/\rightarrow$  to see a specific part of it. Press **ZOOM** several times to return to the original format.

### Repeat and shuffle playback

Press **PLAYMODE** during playback to select among the repeat and shuffle playback modes: Play one, Play all, Shuffle play, Repeat one, Repeat all, Repeat shuffle. The selected repeat mode shows briefly on the TV screen.

## Player menus

The player menus show when the unit is just turned on or when **SETUP** is pressed. Navigate through the menus using the navigation keys ( $\wedge/\vee/\leftarrow/\rightarrow$ ) and confirm your selections by pressing **OK**.



### Live signal

Select this option to view the currently selected device (DV, INPUT1 or INPUT 2). Refer to page 10 for details.

### Play disc

Select this option to view loaded disc in the unit. This has the same function as you press  $\blacktriangleright\blacktriangleleft$  of the DVD player.

### Disc operation



### Format Disc

You may be required to format your DVD±R/RW before using. All existing content on the disc will be erased after formatting.

### Finalize

To close the disc session. You need to finalize a DVD±RW to make it compatible with other DVD players. This option will change as "Unfinalize" if a finalized DVD±RW disc is loaded. You may unfinalize the disc for further recording.

### Rename Disc Label

To change the name of the disc. Press  $\wedge/\vee/\leftarrow/\rightarrow$  to navigate through the rename menu and press **OK** to confirm selections.

## Recording manager

EN

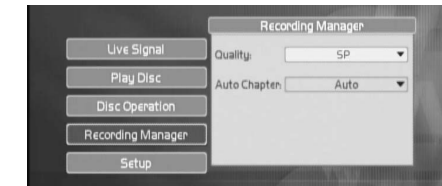

### Quality

To select the DVD±RW recording quality. The higher the quality, the shorter is the recordable time.

- HQ (1 hour), SP (2 hours), LP (3 hours), EP (4 hours), EP+ (7 hours) (Estimation based on single-layered 4.7GB blank disc)

This has the same function as you press **RECORD QUALITY** on the remote control.



### Auto Chapter

To select the interval time to add automatic chapter markers during DVD recording. Refer to page 15 for details on chapters.

- Auto (5 minutes for HQ, SP, LP and EP recording, 10 minutes for EP+ recording), 5 minutes, 10 minutes, 15 minutes and off.

### Setup

Select this option to access more functions of the player. The sub-menus are as the followings:

### Language

To change the default languages for OSD (on-screen display), DVD menu, DVD Audio and DVD Subtitles. If the disc does not contain the language you have chosen, the disc's default language is automatically selected.

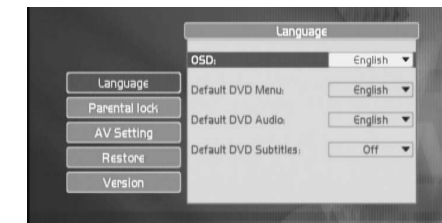

## Player menus

EN

### Parental lock

This function enables you to restrict access to certain DVDs whose content may be deemed unsuitable for your children. Viewing is not possible unless a password that you have chosen is entered. The rating system ranks the ratings from 1 to 8 (1 is considered material that is least offensive and 8 is considered the most offensive).

- 1 KID SAFE – Kid safe; it is safe even for kids.
- 2 G – General Audience; recommended as acceptable for viewers of all ages.
- 3 PG – Parental Guidance suggested.
- 4 PG13 – Material is unsuitable for children under age 13.
- 5 PG-R – Parental Guidance-restricted; recommended that parents restrict children under age 17 from viewing or allow children to view only when supervised by a parent or adult guardian.
- 6 R – Restricted, under 17 requires accompanying parent or adult guardian.
- 7 NC17 – NO children under age 17; not recommended viewing for children under age 17.
- 8 ADULT – Mature material; should be viewed only by adults, due to graphic sexual material, violence, or language.

To change the rating level:

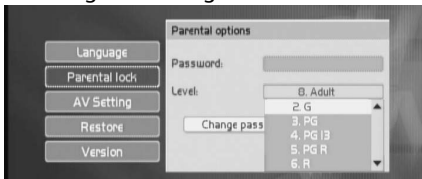

1. Highlight "Level" and then press **OK**.
2. Select a level by pressing ^/∨ and then press **OK**. If a password has already been created, you must enter the correct password with the numeric keys before you can change the rating level.

To change the password:

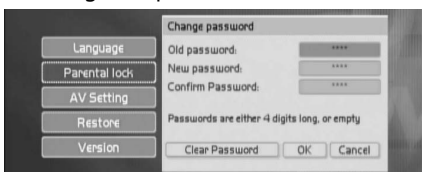

1. Highlight "Change password" and then press **OK**.
2. Enter the old password and new password with the numeric keys. If you are using this feature for the first time, no old password is required.
3. Select "OK" on the menu and then press **OK**.

### AV Setting

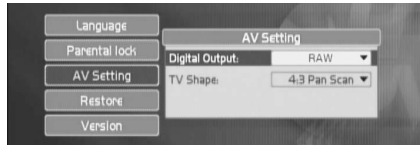

To change the digital output and TV shape settings.

- Digital output: RAW (Dolby 5.1 channels) or PCM (2 channels audio)
- TV shape: 4:3 Letterbox, 4:3 Pan scan and 16:9

### Restore

To reset all settings to factory defaults.

### Version

To display the firmware version of the unit.

## More information

### Troubleshooting

#### General Problems

Unit will not work (locks up)

- Try unplugging the power cord from the DC power jack and plugging it back in.

No power

- Plug in the unit. Make sure the power cable connections at the DC power jack, adapter and AC outlet are securely made.
- Make sure you have plugged it into a working outlet and/or a power strip that is turned on.

No picture

- Turn on the TV.
- Tune your TV to the Video Input Channel that corresponds to the jacks you used to connect the TV to the unit.
- The unit may be in progressive scan video mode. Press the VIDEO OUT button to select the available choices. Try playing the disc again. Some, but not all, High Definition Televisions (HDTVs) and multimedia monitors use progressive scan.
- Make sure your unit is connected properly.
- If you connected a satellite receiver or a cable box, make sure it is turned on.

A screen saver appears on the TV

- The unit is equipped with a screen saver that appears on the TV after it has been idle for several minutes. To make it disappear, press any button on the remote control.

The menu is displayed in a foreign language

- The OSD menu is set to that language. Follow these steps to change the language: 1) Highlight the fifth item from the player menus and then press **OK**. 2) Highlight the first item in the sub-menu and then press **OK**. 3) Highlight the first item in the sub-menu and then press **OK**. 4) Highlight the desired language (English, Spanish, German, French, Italian and Dutch) and then press **OK** from the menu.

I forgot my password

- Enter "9688" as your password, this is the default password. Make sure to change it to a new one and lock the unit again before you turn it off. Store your password in a safe place.

#### DVD Problems

Disc will not eject

- When you put a disc into the player, the player may take up to 1 minute to read the disc and determine the disc type. You will not be able to eject the disc during this time. Wait 1 minute and try again.
- Turn the unit off and on and try it again.
- Try unplugging the power cord from the DC power jack and plugging it back in.

Disc will not play

- Many problems encountered when playing (or recording) a disc are related to the wide variation in disc quality due to the large number of brands and manufacturers. We highly recommend using discs from a reputable manufacturer. If you encounter problems with one brand, please try another brand.
- Insert a disc with the label side facing up.
- Check the type of disc you put into the player. This player only plays DVD video discs, Video CDs (VCD and SVCD), audio CDs, and CDs with true mp3, and/or JPEG files, or WMA files. mp3 files that have been converted to MPX files (or similar types of files) will not be recognized by the unit. If you try to play an incompatible disc type, "BAD DISC" appears on the TV.
- Both the unit and pre-recorded DVD movie discs are coded by region. If the regional codes do not match, the disc cannot be played. This unit is Region No. 1 for North America. Region coding is not applicable to discs you use to record.
- If you are playing a Multisession CD, you might not have closed the session before ejecting it from your computer. Close the session and try the disc again.
- If you are trying to play a DVD±R/RW disc you recorded in this unit in another DVD player, the DVD player may not support DVD±R/RW discs. Also, if it is a DVD±R disc, make sure you finalize it.
- DVD-RAM and CD-RAM discs cannot be played on this unit.
- If the disc appears to be playing but you do not see a picture, make sure the TV is tuned to the correct Video Input Channel for how you connected it to the unit.
- If you are trying to play a disc that was recorded on a PC, it must have been

EN

## More information

EN

recorded using a compatible video format. This product plays DVD video (MPEG2), Video CDs (MPEG1), audio CDs, or data discs (CD-R, CD-RW) with jpeg pictures, mp3s, or WMA files.

Play starts, but then stops immediately

- The disc is dirty. Clean it.
- Condensation has formed in the unit. Allow it to dry out.

The picture is distorted and/or fuzzy, or "jumps" during disc playback

- The disc might be damaged or scratched. Try another disc.
- It is normal for some distortion to appear during forward or reverse scan.
- The disc might be dirty. Clean it.
- Some discs have defects that cause them to jump from one scene to the next.
- The unit may be in progressive scan video mode. Press the VIDEO OUT button to toggle the available choices. Try playing the disc again. Some, but not all High Definition Televisions (HDTVs) and multimedia monitors use progressive scan.
- If you have a progressive scan TV connected, a slight jumping of the signal is normal when you first play a DVD disc. A more detailed explanation follows: If you have a progressive scan TV connected to the DVD recorder via the COMPONENT jacks (Y, Pb, Pr), the DVD recorder automatically switches between progressive scan and regular interlace because progressive scan is only available when you play DVD discs. As the signal is converted from interlace to progressive (and vice versa), the recorder resynchronizes the signal. Depending upon your TV, this resynchronization process might cause a slight "jump" in the picture when you start playing a DVD disc and again when you return to watching TV.

No sound or distorted sound

- Make sure your unit is connected properly. Make sure all cables are securely inserted into the appropriate jacks.
- Turn your TV to its Video Input Channel.
- Sound is muted when you are using search features (fast forward, reverse etc.).
- If you connected an audio receiver to the

unit, make sure you chose the correct input setting on the receiver. Select PCM for 2 channels audio and RAW for Dolby 5.1 channels in the Digital Output menu.

Cannot advance, forward or reverse scan through a movie

- Some discs have sections that prohibit rapid scanning, or title and chapter skip.
- You cannot advance through the opening credits and warning information that appear at the beginning of DVD movies because the disc is programmed to prohibit that action.

Subtitle and/or audio language is not the one selected from the initial setting

- If the subtitle and/or audio language does not exist on the disc, the disc's priority language will be selected instead. Press the SUBTITLE or AUDIO buttons to access the available settings, and press OK to select them.

Desired angle cannot be changed

- Most discs do not have the multi-camera angle system, and some discs only have multiple angles during certain parts of the movie.

Picture is too tall and thin or too short and wide

- Change the TV shape setting for optimal viewing.

### Recording Problems

Not enough space on the DVD+R or DVD+RW disc

- To get more recording time, you can change the Recording Quality setting. If it is a DVD±RW disc, you can delete some titles to create more space.

Will not record

- You cannot record content that is copy-protected and copy DVD movies by connecting a DVD player to the unit.
- Make sure you have inserted a DVD±R/RW disc. You cannot record on DVD-RAM, or any CD discs.
- Many problems encountered when recording (or playing) disc are related to the wide variation in disc quality due to

the large number of brands and manufacturers. We highly recommend using discs from a reputable manufacturer. If you encounter problems with one brand of disc, please try another brand.

### mp3 files problems

The following recommendations cannot be taken as a guarantee that the unit will play mp3 recordings, or as an assurance of sound quality. Certain technologies and methods for mp3 file recording on CD-R discs prevent optimal playback of these files on your product.

- Make sure the file is a true mp3 file. You can only play true mp3 files in the unit — some products use software to compress mp3 files and convert them to other formats such as MPX. Your unit will not recognize or play MPX files or other types of converted mp3 files. Also, if the mp3 file is copy protected from a secure download site, it may not play.
- When naming mp3 files, do not exceed 12 characters, and enter .mp3 as the file extension. When using a general name format of: Title.mp3, make sure the title is 8 characters or less, do not use spaces, and do not use special characters (such as =, +, /, %, &, etc.).
- Whatever the real recording capacity of the CD-R, do not use more than 630MB of recording space on the disc.
- Use a decompression transfer rate of at least 128 kb/sec (kilobits/second) when recording mp3 files. Sound quality with mp3 files basically depends on the rate of compression you choose. Getting audio CD quality sound requires an analog/digital sampling rate, that is conversion to mp3 format, of at least 128 kb/sec and up to 160 kb/sec. However, choosing higher rates like 192 kb/sec or more, only rarely give even better sound quality. Conversely, files with sampling rates below 128 kb/sec will not be played.

### WMA files problems

- WMA files must have sampling rates between 32 and 44k for playback.

### Remote control problems

Remote will not work

- Insert new batteries in the remote.
- Operate the remote control at a distance of no more than 20 feet.
- Remove any obstacles between the remote and the unit or other component. If your unit is in an entertainment cabinet, the glass doors might obstruct the remote control from operating the DVD recorder. Open the doors.

### Camcorder problems

Camcorder does not turn on when connected to the unit

- Make sure you turned on the unit before connecting the camcorder.
- Make sure batteries (with sufficient battery power) are installed in the camcorder.
- Disconnect the camcorder and reconnect again after several seconds.

Cannot start recording from the camcorder

- Make sure the camcorder is properly connected to the unit. The Camcorder Docked indicator lights when the camcorder is connected.
- Make sure the disc you have loaded is recordable.

EN

## More information

EN

### Precautions

- This compact disc player uses a laser to read the music on the disc. The laser mechanism corresponds to the cartridge and stylus of a record player. Although this product incorporates a laser pick-up lens, it is completely safe when operated according to directions.
- Discs rotate at high speed inside the player. Do not use damaged, warped, or cracked discs.
- Do not touch the pick-up lens which is located inside the disc compartment. To keep dust from collecting on the pick-up lens, do not leave the compartment door open for an extended period of time. If the lens becomes dirty, clean it with a soft brush, or use an air blower brush designed for camera lenses.

### Maintenance

For safety reasons, when cleaning the cabinet be sure to disconnect the AC power cord from the AC outlet.

- Do not use benzene, thinner, or other solvents for cleaning.
- Wipe the cabinet with a soft cloth.

### Formation of Condensation

- Due to sharp changes in temperature and humidity, condensation may form if warm air comes in contact with any cold parts inside the player.
- When condensation forms inside the player, the player may not operate correctly. If this occurs, leave the player at room temperature until the inside of the player becomes dry and operational.
- If condensation forms on a disc, wipe the disc with a soft, dry cloth by moving the cloth from the center hole toward the outer edge.

### Handling Discs

- Do not touch the disc's signal surfaces. Hold by the edges or by one edge and the hole in the center.
- Do not affix labels or adhesive tape to label surfaces. Don't scratch or damage the label.
- Do not use damaged (cracked or warped) discs.

### Note

FCC Regulations state that unauthorized changes or modifications to this equipment may void the user's authority to operate it.

This DVD Recorder is designed and manufactured to respond to the Region Management Information. If the Region number of a DVD disc does not correspond to the Region number of this DVD Recorder this DVD Recorder cannot play the disc. The Region number for this DVD Recorder is Region No 1.

This device is protected by U.S. patent numbers 4,631,603 and 4,577,216 and 4,819,098 and other intellectual property rights. The use of Macrovision's copy protection technology in the device must be authorized by Macrovision and is intended for home and other limited pay-per-view uses only, unless otherwise authorized in writing by Macrovision. Reverse engineering or disassembly is prohibited.

### Technical specifications

Product: Small Wonder Dream Maker Player and Recorder  
 Brand: RCA  
 Model: EZDVD1 / EZDVD2  
 Power Supply: 120V~60Hz  
 Power consumption: 20 Watts  
 Dimensions (H x W x D mm):  
 Unit size: 69.5 x 181 x 246.5  
 CD player: Response curve (+/- 2dB):  
 60Hz to 5kHz  
 Rating Plate: Look for it at the bottom of the set.

## Limited warranty

### For U.S.

What your warranty covers:

- Defects in materials or workmanship.

For how long after your purchase:

- One year from date of purchase.
- The warranty period for rental units begins with the first rental or 45 days from date of shipment to the rental firm, whichever comes first.

What we will do:

- Provide you with a new, or at our option, a refurbished unit. The exchange unit is under warranty for the remainder of the original product's warranty period.
- Proof of purchase in the form of a bill of sale or receipted invoice which is evidence that the product is within the warranty period must be presented to obtain warranty service. For rental firms, proof of first rental is also required.

How to make a warranty claim:

- Properly pack your unit. Include any cables, etc., which were originally provided with the product. We recommend using the original carton and packing materials.
- Include evidence of purchase date such as the bill of sale. Also print your name and address and a description of the defect. Send via standard UPS or its equivalent to:  
**Thomson Inc.**  
**Product Exchange Center**  
**11721 B Alameda Avenue**  
**Socorro, Texas 79927**
- Insure your shipment for loss or damage. Thomson accepts no liability in case of damage or loss en route to Thomson.
- Pay any charges billed to you by the Exchange Center for service not covered by the warranty.
- A new or refurbished unit will be shipped to you freight prepaid.

What your warranty does not cover:

- Customer instruction. (Your Owner's Manual provides information regarding operating Instructions and user controls. For additional information, ask your dealer.)
- Installation and set-up service adjustments.
- Batteries.
- Damage from misuse or neglect.
- Products which have been modified or incorporated into other products.
- Products purchased or serviced outside the USA.

- Acts of nature, such as but not limited to lightning damage.

Product Registration:

- Please complete and mail the Product registration Card packed with your unit. It will make it easier to contact you should it ever be necessary. The return of the card is not required for warranty coverage.

Limitation of Warranty:

- THE WARRANTY STATED ABOVE IS THE ONLY WARRANTY APPLICABLE TO THIS PRODUCT. ALL OTHER WARRANTIES, EXPRESS OR IMPLIED (INCLUDING ALL IMPLIED WARRANTIES OF MERCHANTABILITY OR FITNESS FOR A PARTICULAR PURPOSE) ARE HEREBY DISCLAIMED. NO VERBAL OR WRITTEN INFORMATION GIVEN BY THOMSON INC., ITS AGENTS OR EMPLOYEES SHALL CREATE A WARRANTY OR IN ANY WAY INCREASE THE SCOPE OF THIS WARRANTY.
- REPAIR OR REPLACEMENT AS PROVIDED UNDER THIS WARRANTY IS THE EXCLUSIVE REMEDY OF THE CONSUMER. THOMSON INC. SHALL NOT BE LIABLE FOR INCIDENTAL OR CONSEQUENTIAL DAMAGES RESULTING FROM THE USE OF THIS PRODUCT OR ARISING OUT OF ANY BREACH OF ANY EXPRESS OR IMPLIED WARRANTY ON THIS PRODUCT. THIS DISCLAIMER OF WARRANTIES AND LIMITED WARRANTY ARE GOVERNED BY THE LAWS OF THE STATE OF INDIANA. EXCEPT TO THE EXTENT PROHIBITED BY APPLICABLE LAW, ANY IMPLIED WARRANTY OF MERCHANTABILITY OR FITNESS FOR A PARTICULAR PURPOSE ON THIS PRODUCT IS LIMITED TO THE APPLICABLE WARRANTY PERIOD SET FORTH ABOVE.

How state law relates to this warranty:

- Some states do not allow the exclusion nor limitation of incidental or consequential damages, or limitations on how long an implied warranty lasts, so the above limitations or exclusions may not apply to you.
- This warranty gives you specific legal rights, and you also may have other rights that vary from state to state.

If you purchased your product outside the USA:

- This warranty does not apply. Contact your dealer for warranty information.

EN