

IMPORTADOR
Comercializadora Thomson de México, S.A. de C.V.
Álvaro Obregón No. 151. Piso 13.
Col. Roma. Delegación Cuauhtémoc
C.P. 06700. México, D.F.
Teléfono: 52-55-11-020360
RFC: CTM-980723-K55

EXPORTER
Thomson Inc.
P.O. Box 1976
Indianapolis, IN 46206-1976
©2007 Thomson Inc.
Trademark(s) ® Registered
Marque(s) Déposée(s)
Marca(s) ® Registrada(s)
5643 0730 (EN/E)
www.ge-electronics.com
Printed In China

EN/E

It is important to read this instruction book prior to using your new product for the first time.
Es importante leer este manual antes de usar por vez primera su equipo.

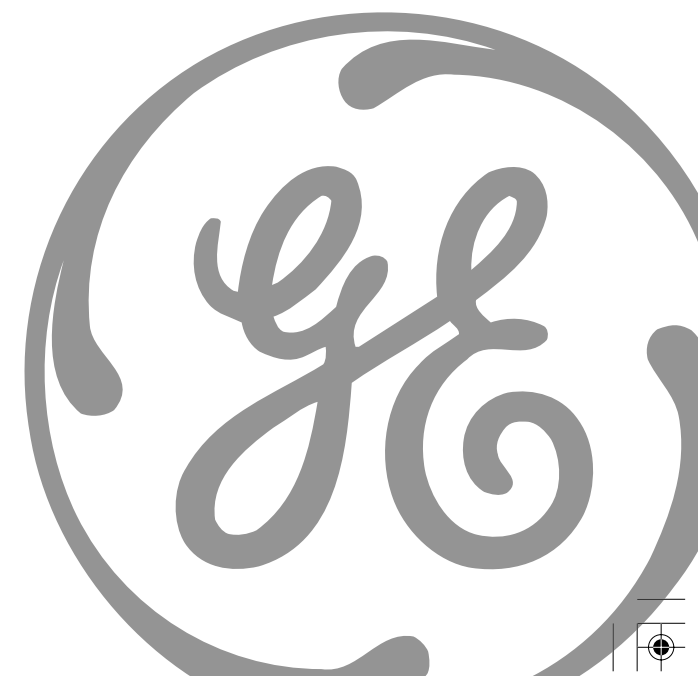

FCC Information

EN

This device complies with Part 15 of the FCC Rules. Operation is subject to the following two conditions: (1) This device may not cause harmful interference, and (2) this device must accept any interference received, including interference that may cause undesired operation. In accordance with FCC requirements, changes or modifications not expressly approved by Thomson Inc. could void the user's authority to operate this product. This equipment has been tested and found to comply with the limits for a Class B digital device, pursuant to Part 15 of FCC Rules. These limits are designed to provide reasonable protection against harmful interference in a residential installation. This equipment generates, uses, and can radiate radio frequency energy and, if not installed and used in accordance with the instructions, may cause harmful interference to radio communications. However, there is no guarantee that interference will not occur in a particular installation. If this equipment does cause harmful interference to radio or television reception, which can be determined by turning the equipment off and on, the user is encouraged to try to correct the interference by one or more of the following measures

- Reorient or relocate the receiving antenna.
- Increase the separation between the equipment and receiver.
- Connect the equipment into an outlet on a circuit different from that to which the receiver is connected.
- Consult the dealer or an experienced radio/TV technician for help.

Also, the Federal Communications Commission has prepared a helpful booklet, "How To Identify and Resolve Radio TV Interference Problems." This booklet is available from the U.S. Government Printing Office, Washington, DC 20402. Please specify stock number 004-000-00345-4 when ordering copies.

This product complies with DHHS Rules 21 CFR Subchapter J. Applicable at the date of manufacture.

This Class B digital apparatus complies with Canadian ICES-003.
Cet appareil numérique de la class B est conforme à la norme de NMB-003 du Canada.

For your safety

The AC power plug is polarized (one blade is wider than the other) and only fits into AC power outlets one way. If the plug won't go into the outlet completely, turn the plug over and try to insert it the other way. If it still won't fit, contact a qualified electrician to change the outlet, or use a different one. **Do not attempt to bypass this safety feature.**

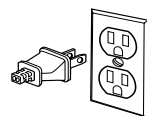

CAUTION: TO PREVENT ELECTRIC SHOCK, MATCH WIDE BLADE OF PLUG TO WIDE SLOT, FULLY INSERT.

Main plug is used as the disconnect device, it shall remain readily operable and should not be obstructed during intended use. To be completely disconnected the apparatus from supply mains, the main plug of the apparatus shall be disconnected from the mains socket outlet completely.



WARNING: TO PREVENT FIRE OR ELECTRICAL SHOCK HAZARD, DO NOT EXPOSE THIS PRODUCT TO RAIN OR MOISTURE.



Equipment tested for compliance as a complete unit

IMPORTER

Comercializadora Thomson de México, S.A. de C.V.
Álvaro Obregón No. 151. Piso 13.
Col. Roma. Delegación Cuauhtémoc
C.P. 06700. México, D.F.
Telefono: 52-55-11-020360
RFC: CTM-980723-K55

FCC Information

Technical Information

Product: Spacemaker
Brand: GE
Model: 7-5350

For Your Records

In the event that service should be required, you may need the model number. In the space below, record the date and place of purchase:

Model No.

Date of Purchase

Place of Purchase

Electrical Consumption

Power Supply: 120V ~ 60Hz
Power Consumption: 72 Watts

Service Information

This product should be serviced only by those specially trained in appropriate servicing techniques. For instructions on how to obtain service, refer to the warranty included in this Guide.

EN

AUDIO AND COMMUNICATIONS DIVISION PLEASE READ AND SAVE THIS FOR FUTURE REFERENCE

IMPORTANT SAFETY INSTRUCTIONS

Some of the following information may not apply to your particular product; however, as with any electronic product, precautions should be observed during handling and use.

- Before using the product, please follow and adhere to all warnings, safety and operating instructions located on the product and in the user book. Save all instructions for future reference.
- Do not expose product to rain and do not use near water; such as, sink, wet basement, swimming pools, etc.
- Always leave sufficient space around the product for ventilation. Do not place product in or on a bed, rug, bookcase or cabinet that may prevent air flow through vent openings.
- Do not expose product to extreme temperatures such as found near a hot radiator or stove, or in a car parked in the Summer sun.
- Connect power cord only to AC power source as marked on the product.
- Some products employ a polarized AC line plug (one blade is wider). This is a safety feature. The plug will go in the power outlet only one way. If the plug doesn't go into the outlet completely, turn the plug over and put it in the other way. If it still doesn't fit, contact a qualified electrician to change the outlet. Do not defeat the safety purpose of the polarized plug.
- Route power cord to prevent it from being pinched, or walked on, or melted by a hot stove or radiator.
- To clean cabinet, unplug AC power cord, then use a soft cloth dampened only with water.
- Do not place lighted candles, cigarettes, cigars, etc. on the product.
- Unplug AC power cord from outlet during a lightning storm or when product is left unused for a long period of time to prevent damage due to lightning or power line surges.
- Care should be taken so that objects do not fall and liquids do not spill into the product.
- Never add accessories that the product has not been designed to accommodate.
- Use only the manufacturer's approved mounting instructions and hardware when installing product.
- Do not attempt to disassemble the cabinet. This product does not contain customer serviceable components.
- Do not handle the unit or power cord when your hands are wet or damp
- Damage Requiring Service—This product should be serviced by qualified service personnel when:
 - A. The power supply cord or the plug has been damaged; or
 - B. Objects have fallen, or liquid has been spilled into the product; or
 - C. The product has been exposed to rain; or
 - D. The product does not appear to operate normally or exhibits a marked change in performance; or
 - E. The product has been dropped, or the cabinet damaged.
- When service or repairs are completed, ask the service technician to perform the safety check described in the service manual and to confirm that replacement parts have the same safety characteristics as the original parts.
- **IF YOUR PRODUCT OPERATES ON BATTERIES,** adhere to the following precautions:
 - A. Any battery may leak electrolyte if mixed with a different battery type, if inserted incorrectly, or if all batteries are not replaced at the same time.
 - B. Any battery may leak electrolyte or explode if disposed of in fire or an attempt is made to charge a battery not intended to be recharged.
 - C. Discard leaky batteries immediately. Leaking batteries can cause skin burns or other personal injury. When discarding batteries, be sure to dispose of them in the proper manner, according to provincial and local regulations.

Table of Contents

FCC Information	Radio Frequency Memory	12
Table of Contents	Memory Recall	12
EN	TV Band	12
First Things First	Using the Weather Band	12
Tools Required	CD Player	13
Parts Packed with Your Unit	Selecting CD Player	13
Before Mounting	Loading CD Disc	13
Mounting Procedure	Play and Pause Playback	13
Before Plug-In	Skip and Search Tracks	13
Setting the Time	End Playback	13
Daylight Saving Time (DST)	Repeat and Random Playback	13
Battery Backup Operation	Using the Countertop Light	14
Installing Backup Battery	Replacing the Bulb	14
General Controls	Display Brightness	14
Main Unit	Troubleshooting Tips	15
Side Views	Remote Control	15
In Battery Compartment	Care and Maintenance	16
The Remote Control	Precautions	16
Display	Cleaning the Exterior	16
Counter timer	Handling Compact Discs	16
Setting the Countdown Timer	Cleaning Compact Discs	16
Radio	CD Lens Care	16
Built-In AFC	U.S. Warranty	17
Antennas		
Turning On the Radio		
Turning Off the Radio		
Adjusting Volume		
Selecting Radio/TV Band		
Tuning to a Station/Channel		
Automatic Station/Channel Search		

First Things First

Under cabinet mounting instructions

Tools required

- Drill and $\frac{1}{4}$ " Drill Bit
- Ruler or Tape Measure
- Nail or Awl
- Scissors
- Screwdriver - Phillips
- Countersink (Optional)
- Masking Tape
- Safety Glasses

Parts packed with your unit

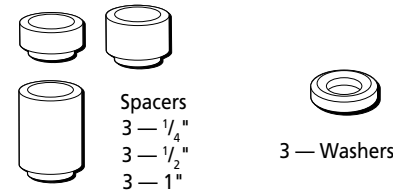

USE:
 3 — $2\frac{3}{4}$ " Phillips head screws
 or
 3 — $1\frac{5}{8}$ " Phillips head screws

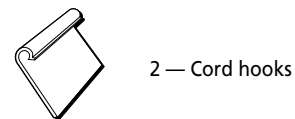

1 — Mounting template

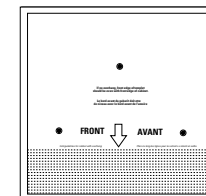

Before mounting

Empty contents of the selected cabinet under which the unit will be mounted and thoroughly clean the underside of the cabinet to remove any grease residue which might be present. We recommend the unit be mounted at the front edge of the cabinet.

Important: For secure mounting, the screws must go into the radio to a depth of at least $\frac{3}{8}$ ". If the overall length from the bottom of the cabinet shelf to the bottom of the overhang is more than $1\frac{3}{4}$ ", then a wood shim will be necessary. A shim can be made from a sheet of plywood, using the Template to locate the central lines for drilling the $\frac{1}{4}$ " mounting holes. The shim can be located between the cabinet shelf bottom and spacers. Make sure the wood is at least as thick as the excess over $1\frac{3}{4}$ ". If a shim is necessary, longer screws are required. Longer screws (Type #10-32) are available at most local hardware stores. Cut out the Template on the line indicated. The Template size and screw hole positions are identical to the top of the clock radio.

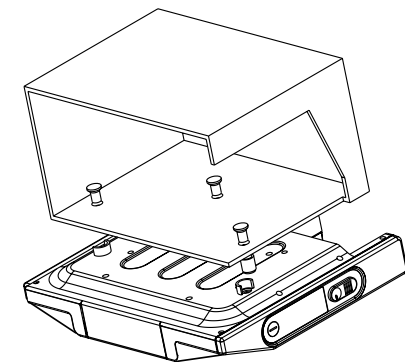

First Things First

Mounting procedure

1. If your cabinet does not have an overhang:
 - (a) Position Template in desired location on underside of cabinet, flush with front edge.
 - (b) Then tape Template in place, and go to Step 2 (Read "Caution").

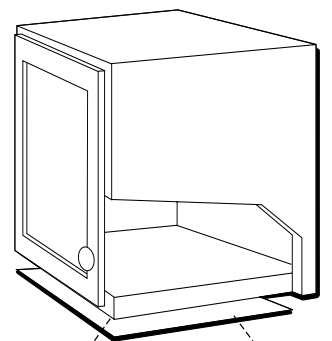

FRONT EDGE OF CABINET MOUNTING TEMPLATE

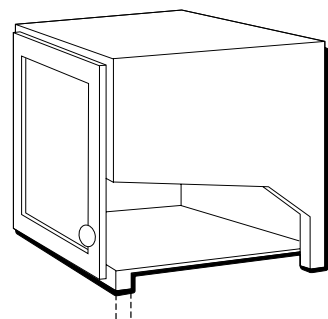

MEASURE THICKNESS OF CABINET OVERHANG

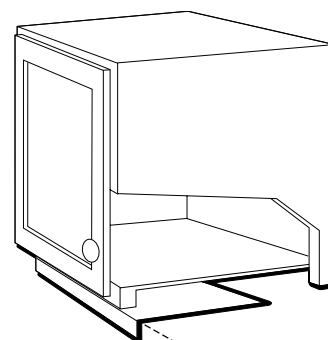

FOLD TEMPLATE ON DOTTED LINE

If your cabinet has an overhang:

- (a) Measure the thickness of the overhang.
- (b) Fold front of Template downward along the printed guideline that is closest to the thickness of your cabinet.
- (c) Tape fold-down portion to backside of overhang, Tape Template to cabinet underside.

EN

First Things First



Note:

If your cabinet has glue blocks or other obstructions, cut out corresponding areas on the Template to clear them. Do not cut out or cut through the screw holes indicated on the Template.

It is recommended that safety glasses be worn while drilling screw holes to prevent the possibility of eye injury.



Tips:

On wooden cabinets you may want to mark and start the drill holes with a nail or an awl.

Be sure to hold the drill very firmly against the cabinet to reduce "walking" of the drill bit from the markings.

Use masking tape above the hole locations on inside of wooden cabinet shelf to help reduce splintering.

If installing the unit under a wood cabinet, you may wish to countersink the drilled hole from the INSIDE of the cabinet if a countersink attachment for your drill is available. This will eliminate the use of washers and allow the screw heads to be flush with the floor of your cabinet. If you cannot countersink the holes, use the supplied washers.

2. Drill $\frac{1}{4}$ -inch diameter holes through the underside of the cabinet bottom shelf using the 3 points marked on the Template.
3. Remove Template and clean drill shavings from inside and underside of cabinet.
4. **If your cabinet does not have an overhang**, go to Step 5.
If your cabinet has an overhang, select the spacer or combination of spacers that is equal to or longer than the cabinet overhang.

EN

First Things First

EN

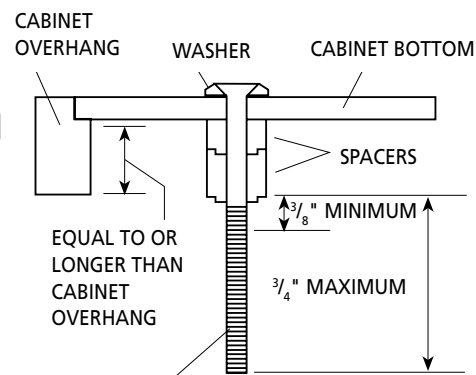

SELECTED SCREWS WHICH MEET MINIMUM, BUT DO NOT EXCEED MAXIMUM LENGTH.

- Insert screws FROM INSIDE THE CABINET. The washers must be used on metal cabinets, and on wood cabinets if you did not countersink the drilled holes. Position washers, flat side down, and place screws into the holes.
If your cabinet does not have an overhang, go to Step 7.
- Hold screw heads down while you push the selected spacers onto the screws under the cabinet. Be sure to push up spacers until they are firmly against the cabinet bottom and/or fully nested (if more than one is used).
- Align radio under the screws. Hold the screw holes in the top of the clock radio against the mounting screws and partially tighten the screws.
Do not fully tighten until all 3 screws have been started. (The top front edge of the clock radio should clear the overhang.)

- Extend cord towards electrical outlet and secure by using the Cord Hooks to hold cord out of the way. For most attractive appearance, place Cord Hooks at back edge of cabinet (on or next to wall) directly over outlet to be used. To attach Cord Hooks, peel off adhesive back and attach to a clean, dry surface on underside of cabinet or back wall. Plug Cord into 120-volt AC electrical outlet. We recommend that the line cord be fully extended for best FM reception.

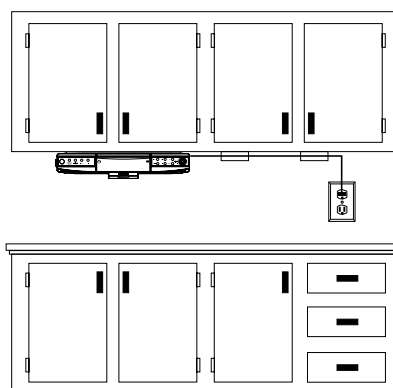

Getting Started

Setting the time

The time display has a 12-hour format with AM and PM indicator. To set the time:

- Press (inside battery compartment) to enter time setting mode.
The red Clock icon will appear on the display.
- To set clock time, use the / buttons to select the correct time.
Press and hold to fast reverse or fast forward clock time.
- Press again to save clock time. The red Clock icon will turn off.



Tips:

In standby mode, press / to show the seconds counter.

Daylight saving time (DST)

After plugging in your unit, daylight saving time must be activated for those areas observing such change.

Press and hold the **DAYLIGHT SAVING** button until the icon lights on the display.
To disable daylight saving time, press and hold again until the icon no longer lights.



Warning:

Please avoid playing with the button after entering the Clock set mode.



The clock setting and daylight saving time button is located in the battery compartment on the side of the unit. Open the compartment door by rotating the lock in the direction of the arrow .

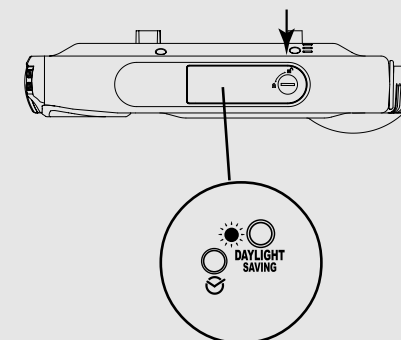

EN

Battery backup operation

This clock radio is equipped with a memory holding system that can be powered with 2 "AAA" batteries (not included). The power failure protection circuit will not operate unless battery is installed.

When normal household power is interrupted, or AC line cord is unplugged, the batteries will power the Spacemaker to keep track of time and timer setting programmed into memory. When the battery backup functions, the digital display will not light. Normal operation will resume after AC power is restored so you will not have to reset the time.

Power failure indicator

The display blinks when AC power is interrupted for more than 2 seconds. You need to reset the clock time to stop the display from blink.

Installing back up battery:

1. The compartment door is located at the side of the Spacemaker.

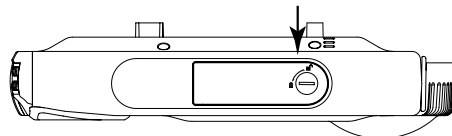

Rotate the lock in the direction of the arrow until it is released. Remove the compartment door.

2. Before inserting the batteries, observe the polarities (that is, + and -) of the batteries, then relate the polarities to the engraved diagram inside the battery compartment. Now insert the batteries.
3. Replace the battery compartment door. Lock the door in place by pushing down on the lock and rotating it in the opposite direction (counterclockwise).



Note:

It is advised that the batteries be replaced every 3 years.

General controls

The main unit

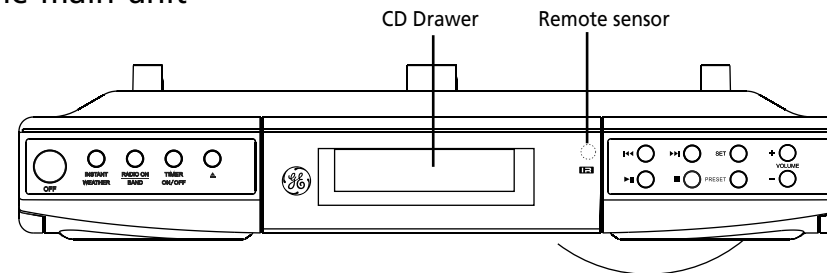

INSTANT WEATHER - Selects weather broadcast stations given by U.S. Government Weather Stations.

RADIO ON / BAND - Turns on radio mode, selects radio bands.

VOL + / - - Adjusts volume.

In standby mode, selects display brightness level (bright (normal) / dim / dimmer).

TIMER ON / OFF - Turns on/ off timer.

SET - Sets radio preset stations.

PRESET - Recalls preset radio stations.

OPEN CLOSE \triangle - Opens/Closes CD disc tray.

STOP \square - Stops CD disc playback.

REV \lll - Tunes down radio frequency, selects the previous TV and weather channel, selects previous CD disc tracks, searches backwards through a track. In standby mode - shows seconds counter.

FWD \ggg - Tunes up radio frequency, selects the next TV and weather channel, selects next CD disc tracks, searches forward through a track. In standby mode - shows seconds counter.

PLAY PAUSE $\triangleright \square$ - Turns on CD mode, starts CD playback, pauses CD disc playback

OFF - Turns the unit off.

Side view

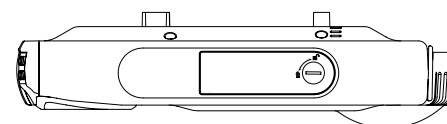

\square / \blacksquare - Opens / locks battery compartment.

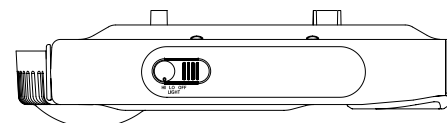

LIGHT (HI / LO / OFF) - Slide the switch to OFF to switch off countertop light, slide to LO for dimmer light, and slide to HI for brighter light.

In battery compartment

DAYLIGHT SAVING \odot - Enables and disables Daylight Saving Time in areas observing/not observing such time change.

⌚ - Sets the clock time.

General Controls

The remote control

EN

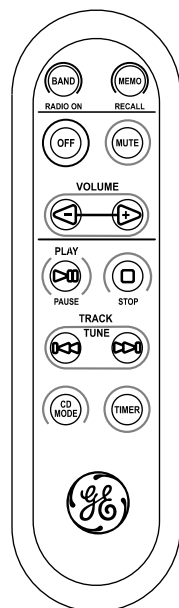

RADIO ON / BAND - Turns on the radio, selects radio bands (AM/FM/TV)

MEMO RECALL - Recalls preset radio stations.

OFF - Turns off the unit.

MUTE - Mutes sound.

VOLUME + / - - Adjusts volume

PLAY/PAUSE - Starts and Pauses disc playback.

STOP - Stops disc playback.

TRACK TUNE - Tunes down radio frequency, selects the previous TV and weather channel, selects previous CD disc tracks, searches backwards through a track.

TRACK TUNE - Tunes up radio frequency, selects the next TV and weather channel, selects next CD disc tracks, searches forward through a track.

CD MODE - Selects among CD playback modes.

TIMER - Turns timer on / off.

Inserting batteries into remote control

The remote control must be inserted with 2 "AAA" batteries (not included) prior to use. Follow the steps below to ensure correct installation.

1. Slide the battery compartment lid open by pushing it in the direction shown by the arrow on the back of the remote control.
2. Before inserting the batteries, observe the polarities (that is, + and -) of the batteries, then relate the polarities to the engraved diagram inside the battery compartment. Now insert the batteries.
3. After installation of the batteries, replace and fit the lid to cover the batteries. You should hear a small "CLICK" sound when the lid is locked in place.

Display

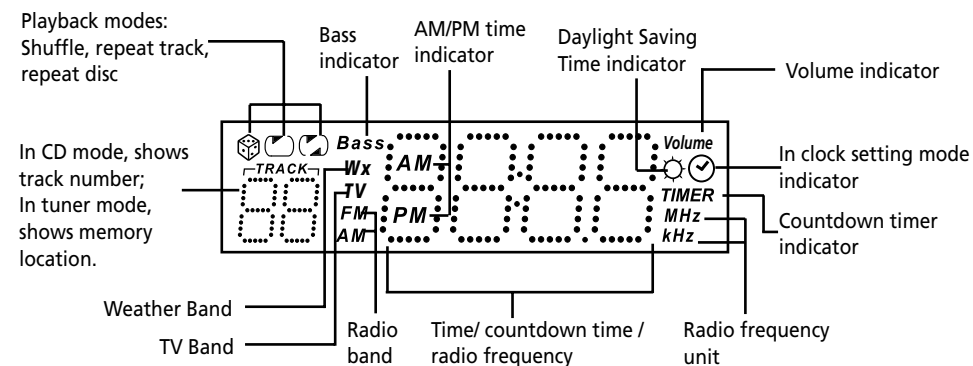

EN

Counter timer

Setting the countdown timer

1. Press **TIMER ON/OFF** to enter timer setting mode.
The red **TIMER** icon will flash on the display.
2. To select countdown time, use the / buttons to select the correct time.
Press and hold to fast reverse or fast forward countdown time.
3. Press **TIMER ON/OFF** again to activate the timer. The unit will beep twice to indicate countdown has started. Remaining time shows on the display.
The red **TIMER** icon will remain lit during countdown.
4. Press **TIMER ON/OFF** to turn timer off at any time or after it has sounded.



Note:

The radio or CD player is muted when alarm turns on.

Radio

Built-In AFC

The Built-In Automatic Frequency Control (AFC) works only on FM. It helps to reduce drift on FM reception and to keep the radio locked in on the FM station to which it is tuned.

EN

Antennas

AM Antenna - A built-in ferrite rod antenna eliminates the need for an outside antenna for AM reception. Rotating the unit slightly may improve reception of distant AM stations.

FM Antenna - The power cord acts as your FM antenna. The power cord picks up moderate to strong stations and eliminates the need for an external antenna in most strong signal areas. Be sure the power cord is stretched out to its full length. Do not coil or bunch the cord together. Changing position of the power cord may improve reception.

Turning on the radio

Press **RADIO ON / BAND** to turn on the radio.

Turning off the unit

Press **OFF** to turn off the radio.

Adjusting volume

Press **VOL -** to decrease volume level.

Press **VOL +** to increase volume level.

Selecting radio / TV band

Press **RADIO ON / BAND** to select between FM, AM and TV band.



Tuning to a station/channel

Press  to tune down radio frequency or select the previous TV channel.



Press  to tune up radio frequency or select the next TV channel.



Note:

The display will return to the clock time after displaying the station frequency or channel number for a few seconds. To view the current station frequency or channel number, press  or .



Automatic station/channel search

Press and hold  or  for more than 1 second and release to start automatic station/channel search in the direction selected.

Search will stop once a station is found.



Tips:

Press  or  to quit automatic station/channel search.

Radio

Radio frequency memory

1. Follow steps in "Selecting Radio Band" and "Tuning to a Station/Channel" to tune to the station you want to store into memory.
2. Press **SET** to assign the next available memory location to the selected station. "P" will flash with the next available memory location light on the display

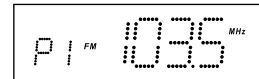

- If you wish to assign another memory location or overwrite a previously set memory, press **PRESET (MEMO RECALL)** on remote control repeatedly to select the memory location.
3. Press **SET** again to confirm selection.



Tips: Press and hold **PRESET (MEMO RECALL)** on remote control for around 4 seconds to delete a selected preset radio station. The memory location will become empty.

A Maximum of 10 preset memory locations are available.

Memory recall

Press **PRESET (MEMO RECALL)** on remote control repeatedly to recall preset stations.

TV band

CH 2-13 are available for TV Band.

The TV indicator and the channel number lights on the display when TV band is selected.

TV Band

ch 2	59.75 MHz
ch 3	65.75 MHz
ch 4	71.75 MHz
ch 5	81.75 MHz
ch 6	87.75 MHz
ch 7	179.75 MHz
ch 8	185.75 MHz
ch 9	191.75 MHz
ch 10	197.75 MHz
ch 11	203.75 MHz
ch 12	209.75 MHz
ch 13	215.75 MHz

Using the weather band

Weather information is given continuously from U.S. Government Weather Stations on frequencies from 162.4MHz to 162.55MHz.

Weather Band

ch 1	162.550 MHz
ch 2	162.400 MHz
ch 3	162.475 MHz
ch 4	162.425 MHz
ch 5	162.450 MHz
ch 6	162.500 MHz
ch 7	162.525 MHz





Important:

The listening range of NOAA weather stations varies from 10 miles up to a maximum of 40 miles from the station's transmitter. In some areas of the United States, weather transmissions cannot be monitored. The effective range of this radio will have side variations due to the height of the local transmitting antenna, atmospheric conditions, and the terrain between the transmitter and your radio's location.



Radio

The Weather transmission, broadcast 24 hours a day, are taped messages that are repeated every 4 to 6 minutes and revised and updated as needed to match the changing weather conditions. For additional information, check your location office of the National Weather Service (Department of Commerce).

1. Press the **INSTANT WEATHER** button to access Weather Bands with strong signals to the unit.
The Wx indicator and the channel number lights on the display when weather band is selected.
2. Use the  or  arrow buttons to select among the 7 weather channels.

CD player

Loading CD disc

1. Press the **OPEN CLOSE**  button to open the disc tray.
2. Insert CD disc with label side facing up.
3. Press **OPEN CLOSE**  again to close the disc tray.

Play and pause playback



Press **PLAY PAUSE**  to start playback.
Press again to pause. The track number will flash when in pause mode.
Press again to resume.



Note:

If no disc is in the disc compartment "nd" will show on the display.

Skip and search tracks





Press  to go to the previous track.
Press and hold to quick search backwards through a track.
Press  to go to the next track.
Press and hold to quick search forward through a track.

End playback

Press **STOP**  to end playback.

Repeat and random playback

Press **CD MODE** on the remote control repeatedly to select among playback modes.

-  - Repeat track
-  - Repeat disc
-  - Random playback
-  - Repeating all tracks on the disc in random order

Using the Countertop Light

The countertop light switch is located on the side of the unit, and has three settings: HI, LO, and OFF.

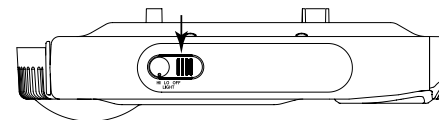

- For dimmer light, move the light switch to the LO position.
- For more illumination, switch to HI.
- To turn the light off, place Light switch to OFF.

Replacing the Bulb

1. Unplug the unit cord from the AC power outlet.
2. Unlatch the cover to open it.
3. Unscrew and remove the bulb.
4. Install the replacement bulb.
5. Swing the cover up and snap it in place.
6. Plug the cord into the AC outlet, and reset the clock.

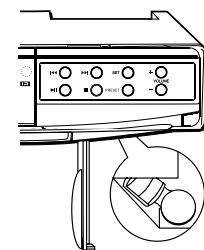

Caution:

Use only appliance-type bulb with a maximum of 40-watt or equivalent for replacement. To prevent hazard, do not operate light without the cover.

Display brightness

In standby mode, press **VOL -** or **+** to select display brightness level (bright (normal) / dim / dimmer)

Troubleshooting tips

Remote Control

- *Is the unit plugged into a working AC outlet?*
Try plugging it into one that you know will work.
- *Is the unit on?*
Press **RADIO ON / BAND** or **PLAY PAUSE** to turn the unit on.
- *Have you selected the correct function when pressing on the buttons?*
For example, if the unit is in CD mode and you try tuning to a particular radio frequency, the remote control is not going to look like it's working. In such cases, press **RADIO ON / BAND** to select radio or **PLAY PAUSE** to select CD function first, then press on the buttons.
- *Are the batteries weak?*
Try replacing old batteries with some fresh ones.
- *Are you pointing the remote control directly at the unit while pressing the buttons?*
You should be, because the remote control sensor at the unit is right at the center of the display.
- *Are you too far from the unit when using the remote control?*
The remote control sensor can only sense signals (from the remote control) within a limited distance. So move closer towards the unit.
- *Are there any obstacles between the remote control and the unit?*
If there are, move all objects standing in the way between the remote control and the unit.

EN

Care and maintenance

Precautions

- Never open the cabinet under any circumstances. Any repairs or internal adjustments should be made only by a trained technician.
- Warning: Never operate this product with the cabinet removed.
- The CD player of this unit uses a laser to read the music on the disc. The laser mechanism corresponds to the cartridge and stylus of a record player. Although this product incorporates a laser pick-up lens, it is completely safe when operated according to directions.
- Discs rotate at high speed inside the player. Do not use damaged, warped or cracked discs.
- Do not touch the pick-up lens which is located inside the disc compartment. Also, to keep dust from collecting on the pick-up lens, do not leave the compartment door open for an extended period of time.
- The apparatus shall not be exposed to dripping or splashing and that no objects filled with liquids, such as vases, shall be placed on the apparatus.
- No naked flame sources, such as lighted candles, should be placed on the apparatus.
- Attention should be drawn to the environmental aspects of battery disposal.

Cleaning the Exterior

Prior to cleaning the exterior, be sure to unplug the power cord from the AC power outlet. Wipe the exterior with a soft, clean, and slightly water-dampened cloth.

Handling Compact Discs

- Do not touch the signal surfaces. Hold by the edges, or by one edge and the hole.
- Do not affix labels or adhesive tape to the label surfaces. Also, do not scratch or damage the label.
- Discs rotate at high speeds inside the player. Do not use damaged (cracked or warped) discs.

Cleaning Compact Discs

- Dirty discs can cause poor sound quality. Always keep discs clean by wiping them gently with a soft cloth from the inner edge toward the outer perimeter.
- If a disc becomes dirty, wet a soft cloth in water, wring it out well, wipe the dirt away gently, and then remove any water drops with a dry cloth.
- Do not use record cleaning sprays or anti-static agents on discs. Also, never clean discs with benzene, thinner, or other volatile solvents which may cause damage to the disc surface.

CD Lens Care

When your CD lens gets dirty it can also cause the unit to output poor sound quality. To clean the lens you will need to purchase a CD lens cleaner which can maintain the output sound quality. For instructions on cleaning the CD lens, refer to the ones accompanying the lens care.

EN

The descriptions and characteristics in this owner's manual are for the purpose of general reference only and not as a guarantee. In order to provide you with the highest quality product, we may make changes or modifications without prior notice. The English version serves as the final reference on all product and operational details should any discrepancies arise in other languages.

U.S. Warranty

What your warranty covers:

- Defects in materials or workmanship.

For how long after your purchase:

- One year from date of purchase.

The warranty period for rental units begins with the first rental or 45 days from date of shipment to the rental firm, whichever comes first.

What we will do:

- Provide you with a new, or at our option, a refurbished unit. The exchange unit is under warranty for the remainder of the original product's warranty period.
- Proof of purchase in the form of a bill of sale or receipted invoice which is evidence that the product is within the warranty period must be presented to obtain warranty service. For rental firms, proof of first rental is also required.

How to make a warranty claim:

- Properly pack your unit. Include any cables, etc., which were originally provided with the product. We recommend using the original carton and packing materials.
- Include evidence of purchase date such as the bill of sale. Also print your name and address and a description of the defect. Send via standard UPS or its equivalent to:

Thomson Inc.

Product Exchange Center
11721 B Alameda Avenue
Socorro, Texas 79927

- Insure your shipment for of loss or damage. Thomson accepts no liability in case of damage or loss en route to Thomson.
- Pay any charges billed to you by the Exchange Center for service not covered by the warranty.
- A new or refurbished unit will be shipped to you freight prepaid.

What your warranty does not cover:

- Customer instruction. (Your Owner's Manual provides information regarding operating Instructions and user controls. For additional information, ask your dealer.)
- Installation and set-up service adjustments.
- Batteries.
- Damage from misuse or neglect.
- Products which have been modified or incorporated into other products.

- Products purchased or serviced outside the USA.
- Acts of nature, such as but not limited to lightning damage.

Limitation of Warranty:

- **THE WARRANTY STATED ABOVE IS THE ONLY WARRANTY APPLICABLE TO THIS PRODUCT. ALL OTHER WARRANTIES, EXPRESS OR IMPLIED (INCLUDING ALL IMPLIED WARRANTIES OF MERCHANTABILITY OR FITNESS FOR A PARTICULAR PURPOSE) ARE HEREBY DISCLAIMED. NO VERBAL OR WRITTEN INFORMATION GIVEN BY THOMSON INC., ITS AGENTS OR EMPLOYEES SHALL CREATE A GUARANTY OR IN ANY WAY INCREASE THE SCOPE OF THIS WARRANTY.**
- **REPAIR OR REPLACEMENT AS PROVIDED UNDER THIS WARRANTY IS THE EXCLUSIVE REMEDY OF THE CONSUMER. THOMSON INC. SHALL NOT BE LIABLE FOR INCIDENTAL OR CONSEQUENTIAL DAMAGES RESULTING FROM THE USE OF THIS PRODUCT OR ARISING OUT OF ANY BREACH OF ANY EXPRESS OR IMPLIED WARRANTY ON THIS PRODUCT. THIS DISCLAIMER OF WARRANTIES AND LIMITED WARRANTY ARE GOVERNED BY THE LAWS OF THE STATE OF INDIANA. EXCEPT TO THE EXTENT PROHIBITED BY APPLICABLE LAW, ANY IMPLIED WARRANTY OF MERCHANTABILITY OR FITNESS FOR A PARTICULAR PURPOSE ON THIS PRODUCT IS LIMITED TO THE APPLICABLE WARRANTY PERIOD SET FORTH ABOVE.**

How state law relates to this warranty:

- Some states do not allow the exclusion nor limitation of incidental or consequential damages, or limitations on how long an implied warranty lasts, so the above limitations or exclusions may not apply to you.
- This warranty gives you specific legal rights, and you also may have other rights that vary from state to state.

If you purchased your product outside the USA:

- This warranty does not apply. Contact your dealer for warranty information.